







PA254 – 10.16

Double deck rising clamp terminal block



TECHNICAL DATA

	IEC	UL / CSA	
Pitch	10.16 mm	0.4"	
Poles	2 + 2, 3 + 3		
Versions	VE vertical		
Ratings	450V - 16A	300V - 15A	
Wire size	2.5 sqmm	26 ÷ 12 AWG	
Working Temperature	-5 ÷ 85 °C (short time 115 °C)	23 ÷ 284 °F	
Plastic Material	Green Polyamide PA6.8, UL94-V0, CTI600V, GWT960 °C		
Metal Parts	Soldering pin made in tin plated brass; Cage insert made in nickel plated brass; M3 Screw made in zinc plated steel		
Screw Torque	0.5 Nm	7 lb-in	
Accessories	CAR-IND		
Approvals	File Nr.	Ratings (sqmm/AWG – V – A – T)	Standard References
	E4332	2.5sqmm - 450V - 16A - 85 °C	EN60998-1; EN60998-2-1
	121269 ÜG	2.5sqmm - 450V - 16A - 85 °C	DIN EN60998-1; DIN EN60998-2-1 (VDE 0613)
	E76048 vol. 1 sec. 7	26 ÷ 12AWG - 300V - 15A - 140 °C	UL1059
	LR 40455	26 ÷ 12 AWG - 300V - 15A	CSA C22-2 N.158-1987; E.C.N 584B

DIMENSIONAL DRAWING

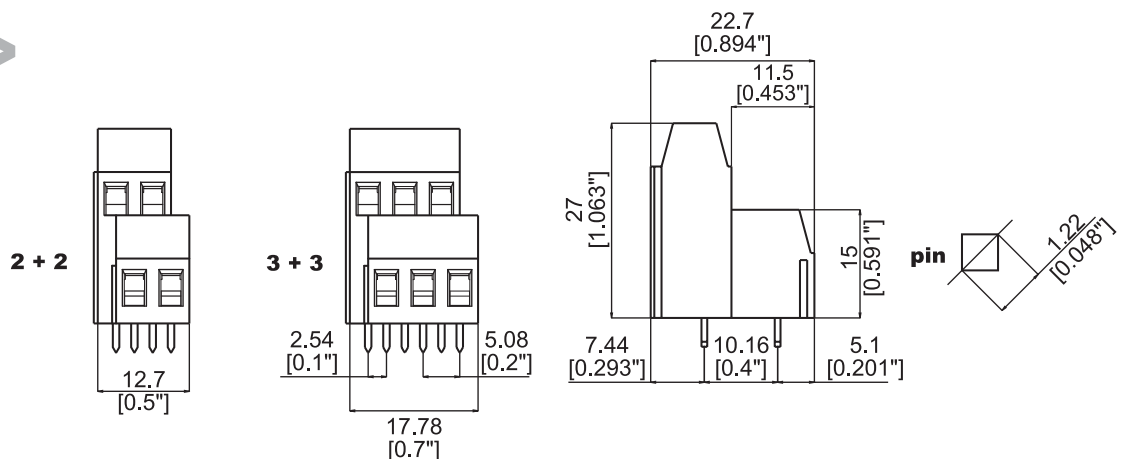



PA254 – 10.16

ACCESSORIES

CAR-IND

Self adhesive label of ten symbols.
Package of 10 sheets each with 25 labels.

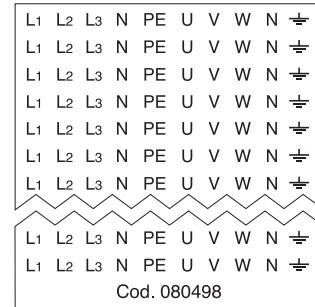
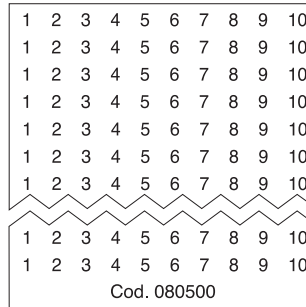

PACKAGING

Type	P-N	Pack
PA 254/10.16/2+2	00112204	50
PA 254/10.16/3+3	00112206	50

CAR-IND

Type	P-N	Pack
L1, L2, L3, N, PE, U, V, W, N,	00080498	250
Neutral	00080499	250
1+ 10	00080500	250
11+ 20	00080501	250
21+ 30	00080502	250
31+ 40	00080503	250
41+ 50	00080504	250
51+ 60	00080505	250
61+ 70	00080506	250
71+ 80	00080507	250
81+ 190	00080508	250
91+ 100	00080509	250

PALLETS

Europallets









PA254 – 15.24

Double deck rising clamp terminal block



TECHNICAL DATA

	IEC	UL / CSA	
Pitch	15.24 mm	0.6"	
Poles	2 + 2, 3 + 3		
Versions	VE vertical		
Ratings	450V - 16A	300V - 15A	
Wire size	2.5 sqmm	26 ÷ 12 AWG	
Working Temperature	-5 ÷ 85 °C (short time 115 °C)	23 ÷ 284 °F	
Plastic Material	Green Polyamide PA6.8, UL94-V0, CTI600V, GWT960 °C		
Metal Parts	Soldering pin made in tin plated brass; Cage insert made in nickel plated brass; M3 Screw made in zinc plated steel		
Screw Torque	0.5 Nm	7 lb-in	
Accessories	CAR-IND		
Approvals	File Nr.	Ratings (sqmm/AWG – V – A – T)	Standard References
	E4332	2.5sqmm - 450V - 16A - 85 °C	EN60998-1; EN60998-2-1
	121269 ÜG	2.5sqmm - 450V - 16A - 85 °C	DIN EN60998-1; DIN EN60998-2-1 (VDE 0613)
	E76048 vol. 1 sec. 7	26 ÷ 12AWG - 300V - 15A - 140 °C	UL1059
	LR 40455	300V - 15A	CSA C22-2 N.158-1987; E.C.N 584B

DIMENSIONAL DRAWING

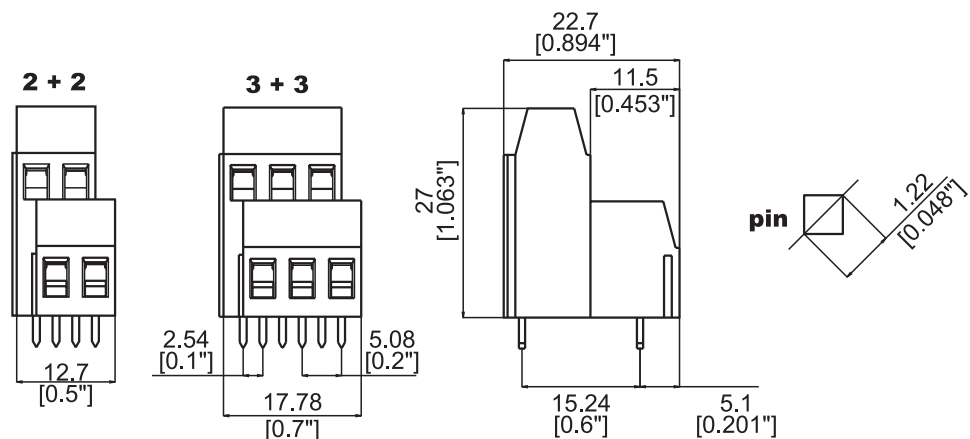



PA254 – 15.24

ACCESSORIES

CAR-IND

Self adhesive label of ten symbols.
Package of 10 sheets each with 25 labels.

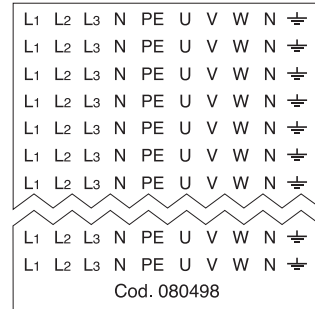
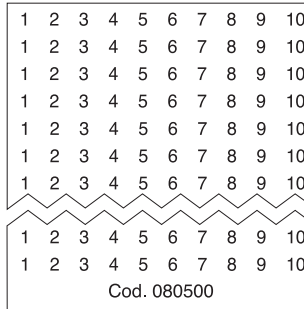

PACKAGING

Type	P-N	Pack
PA 254/15.24/2+2	00112104	50
PA 254/15.24/3+3	00112106	50

CAR-IND

Type	P-N	Pack
L1, L2, L3, N, PE, U, V, W, N,	00080498	250
Neutral	00080499	250
1+ 10	00080500	250
11+ 20	00080501	250
21+ 30	00080502	250
31+ 40	00080503	250
41+ 50	00080504	250
51+ 60	00080505	250
61+ 70	00080506	250
71+ 80	00080507	250
81+ 190	00080508	250
91+ 100	00080509	250

PALLETS

Europallets

