



PA258 – 5

ACCESSORIES

CAR-IND

Self adhesive label of ten symbols.
Package of 10 sheets each with 25 labels.

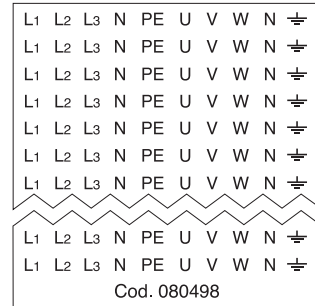
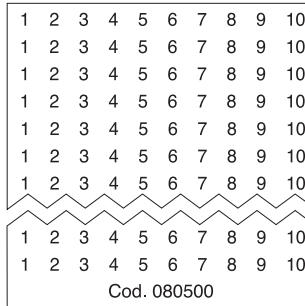

PACKAGING

Type	P-N	Pack
PA 258/5/2VE	00112802	100
PA 258/5/3VE	00112803	100
PA 258/5/2HO	00112842	100
PA 258/5/3HO	00112843	100

CAR-IND

Type	P-N	Pack
L1, L2, L3, N, PE, U, V, W, N,	00080498	2500
Neutral	00080499	2500
1+ 10	00080500	2500
11+ 20	00080501	2500
21+ 30	00080502	2500
31+ 40	00080503	2500
41+ 50	00080504	2500
51+ 60	00080505	2500
61+ 70	00080506	2500
71+ 80	00080507	2500
81+ 190	00080508	2500
91+ 100	00080509	2500

PALLETS

Europallets







PA258 - 10

Rising clamp terminal block



TECHNICAL DATA

	IEC	UL / CSA	
Pitch	10 mm	0.39"	
Poles	1, 2		
Versions	VE vertical - HO horizontal		
Ratings	750V - 24A	300V - 15A	
Wire size	2.5 sqmm	26 ÷ 14 AWG	
Working Temperature	-5 ÷ 85 °C (short time 115 °C)	23 ÷ 284 °F	
Plastic Material	Green Polyamide PA6.8, UL94-V0, CTI600V, GWT960 °C		
Metal Parts	Soldering pin made in tin plated brass; Cage insert made in nickel plated brass; M3 Screw made in zinc plated steel		
Screw Torque	0.5 Nm	7 lb-in	
Accessories	CAR-IND		
Approvals	File Nr.	Ratings (sqmm/AWG - V - A - T)	Standard References
	EG 277	2.5sqmm - 750V - 24A - 85 °C	EN60998-1; EN60998-2-1
	E76048 vol. 1 sec. 7	26 ÷ 14AWG - 300V - 15A - 140 °C	UL1059
	LR40455	26 ÷ 14AWG - 300V - 15A	CSA C22-2 N.158-1987; E.C.N 584B

DIMENSIONAL DRAWING

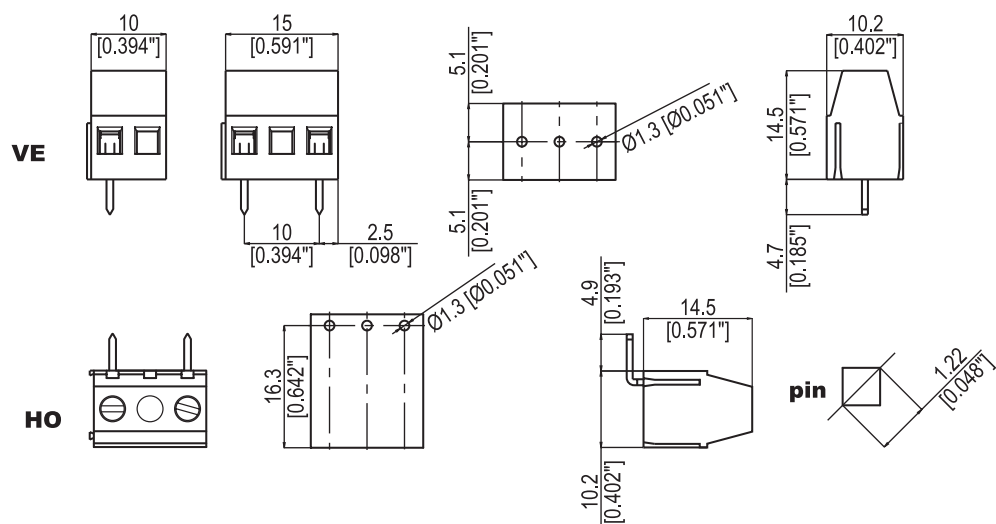



PA258 – 10

ACCESSORIES

CAR-IND

Self adhesive label of ten symbols.
Package of 10 sheets each with 25 labels.

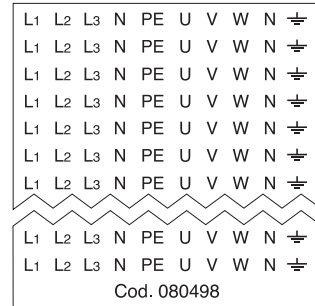
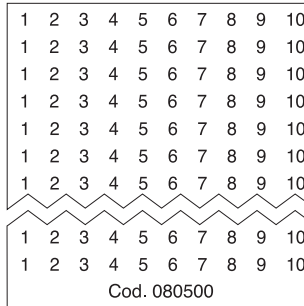

PACKAGING

Type	P-N	Pack
PA 258/10/1VE	00112881	100
PA 258/10/2VE	00112882	100
PA 258/10/1HO	00112891	100
PA 258/10/2HO	00112892	100

CAR-IND

Type	P-N	Pack
L1, L2, L3, N, PE, U, V, W, N, Neutral	00080498	250
1+ 10	00080499	250
11+ 20	00080500	250
21+ 30	00080501	250
31+ 40	00080502	250
41+ 50	00080503	250
51+ 60	00080504	250
61+ 70	00080505	250
71+ 80	00080506	250
81+ 190	00080507	250
91+ 100	00080508	250
	00080509	250

PALLETS

Europallets

